

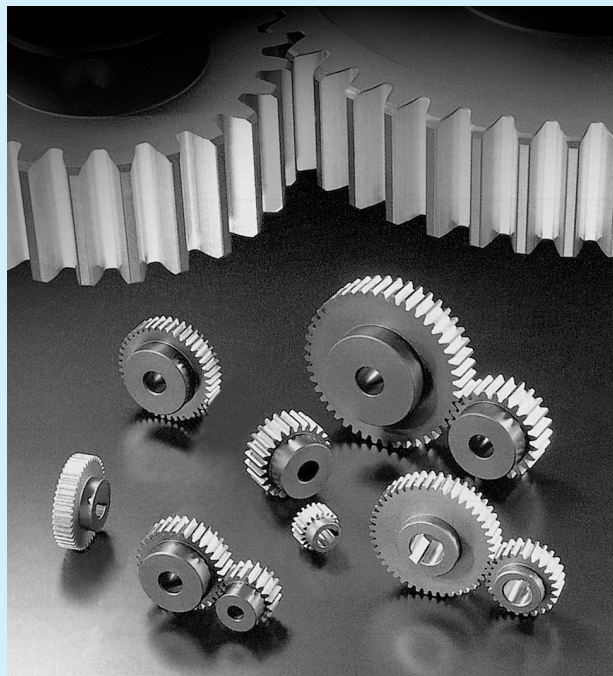

標準平齒車



■ 카다로그 규격 : ESSA, ESSB

● 특징

- 1. ESG 표준평기어는 모듈, 형상, 잇수가 다양하므로 사용측에 맞추어 자유롭게 가공할 수 있는 경제적인 제품으로 압력각은 20°이며 2축의 중심거리는

$$\frac{PCD+PCD}{2} = \frac{m(Z_1+Z_2)}{2} \text{로 사용해야 한다.}$$

Z₁ = 소치차의 잇수

Z₂ = 대치차의 잇수

- 표준평기어의 종류 : -모듈 M1~M8
-재질 SM45C

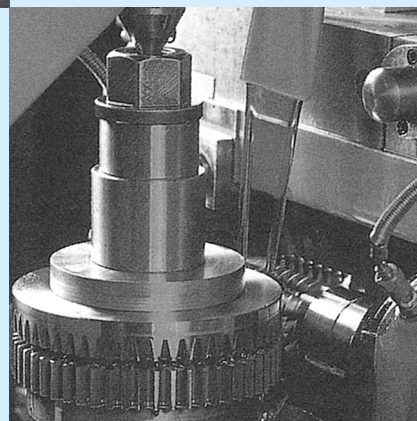



ESSA

SPUR GEAR

MODULE 1

標準平齒車

●材質 : SM45C ●壓力角 : 20°

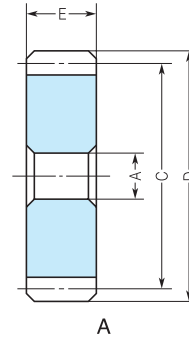
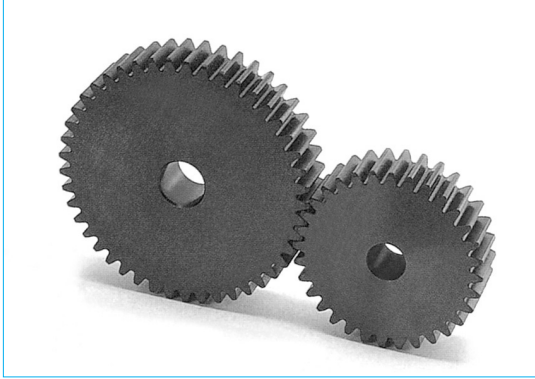

ESSA

■平齒車 (齒幅 12, 10mm)

규격	잇수	내경	피치원직경	치선원직경	치 폭	중량 (kg)
	Z	A _{H7}	C	D	E	
ESSA 1014	14	6	14	16	12	0.01
ESSA 1015	15	6	15	17	12	0.01
ESSA 1016	16	8	16	18	12	0.01
ESSA 1018	18	8	18	20	10	0.02
ESSA 1020	20	8	20	22	10	0.03
ESSA 1024	24	8	24	26	10	0.03
ESSA 1025	25	8	25	27	10	0.03
ESSA 1028	28	10	28	30	10	0.05
ESSA 1030	30	10	30	32	10	0.05
ESSA 1032	32	10	32	34	10	0.06
ESSA 1035	35	10	35	37	10	0.07
ESSA 1036	36	10	36	38	10	0.07
ESSA 1040	40	10	40	42	10	0.09
ESSA 1045	45	10	45	47	10	0.12
ESSA 1048	48	10	48	50	10	0.14
ESSA 1050	50	10	50	52	10	0.15
ESSA 1056	56	10	56	58	10	0.20
ESSA 1060	60	10	60	62	10	0.22
ESSA 1064	64	10	64	66	10	0.25
ESSA 1065	65	10	65	67	10	0.26
ESSA 1070	70	10	70	72	10	0.28
ESSA 1072	72	10	72	74	10	0.31
ESSA 1075	75	10	75	77	10	0.34
ESSA 1080	80	10	80	82	10	0.39
ESSA 1085	85	10	85	87	10	0.40
ESSA 1090	90	12	90	92	10	0.44
ESSA 1095	95	12	95	97	10	0.52
ESSA 10100	100	12	100	102	10	0.64

* 상기 기어의 동력전달표는 74페이지를 참고하십시오.



ESSB

SPUR GEAR

MODULE 1

標準平齒車

●材質：SM45C ●壓力角：20°

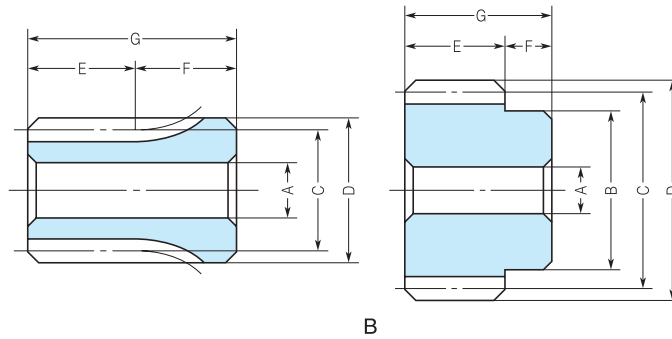

■平齒車 (齒幅 12, 10mm)

규격	잇수	내경	보스경	피치원직경	치선원직경	치 폭	보스길이	전장	중량 (kg)
	Z	A _{H7}	B	C	D	E	F	G	
ESSB 1008	8	-	10.64	8	10.64	12	32	60	(B) 0.04
ESSB 1010	10	-	12.66	10	12.66	12	32	60	0.06
ESSB 1012	12	6	14	12	14	12	13	25	0.02
ESSB 1013	13	6	15	13	15	12	13	25	0.02
ESSB 1014	14	6	16	14	16	12	13	25	0.02
ESSB 1015	15	6	17	15	17	12	13	25	0.02
ESSB 1016	16	8	18	16	18	12	13	25	0.02
ESSB 1017	17	8	19	17	19	12	13	25	(B) 0.02
ESSB 1018	18	8	15	18	20	10	10	20	0.02
ESSB 1019	19	8	16	19	21	10	10	20	0.04
ESSB 1020	20	8	16	20	22	10	10	20	0.04
ESSB 1021	21	8	18	21	23	10	10	20	0.04
ESSB 1022	22	8	18	22	24	10	10	20	0.04
ESSB 1023	23	8	20	23	25	10	10	20	0.04
ESSB 1024	24	8	20	24	26	10	10	20	0.05
ESSB 1025	25	8	20	25	27	10	10	20	0.05
ESSB 1026	26	8	22	26	28	10	10	20	0.06
ESSB 1027	27	8	22	27	29	10	10	20	0.07
ESSB 1028	28	10	24	29	30	10	10	20	0.08
ESSB 1029	29	10	24	29	31	10	10	20	0.08
ESSB 1030	30	10	25	30	32	10	10	20	0.09
ESSB 1032	32	10	25	32	34	10	10	20	0.10
ESSB 1034	34	10	26	34	36	10	10	20	0.10
ESSB 1035	35	10	26	35	37	10	10	20	0.10
ESSB 1036	36	10	28	36	38	10	10	20	0.11
ESSB 1038	38	10	28	38	40	10	10	20	0.13
ESSB 1040	40	10	30	40	42	10	10	20	0.14
ESSB 1042	42	10	30	42	44	10	10	20	0.16
ESSB 1044	44	10	30	44	46	10	10	20	0.16
ESSB 1045	45	10	30	45	47	10	10	20	0.18
ESSB 1046	46	10	30	46	48	10	10	20	0.20
ESSB 1048	48	10	30	48	50	10	10	20	0.22
ESSB 1050	50	10	35	50	52	10	10	20	0.24
ESSB 1052	52	10	35	52	54	10	10	20	0.24
ESSB 1054	54	10	35	54	56	10	10	20	0.24
ESSB 1055	55	10	35	55	57	10	10	20	0.24
ESSB 1056	56	10	35	56	58	10	10	20	0.26
ESSB 1058	58	10	35	58	60	10	10	20	0.27
ESSB 1060	60	10	35	60	62	10	10	20	0.28
ESSB 1062	62	10	40	62	64	10	10	20	0.32
ESSB 1064	64	10	40	64	66	10	10	20	0.34
ESSB 1065	65	10	40	65	67	10	10	20	0.35
ESSB 1066	66	10	40	66	68	10	10	20	0.37
ESSB 1068	68	10	40	68	70	10	10	20	0.38
ESSB 1070	70	10	42	70	72	10	10	20	0.41
ESSB 1072	72	10	45	72	74	10	10	20	0.44
ESSB 1075	75	10	45	75	77	10	10	20	0.47
ESSB 1076	76	10	45	76	78	10	10	20	0.49
ESSB 1080	80	12	50	80	82	10	10	20	0.54
ESSB 1084	84	12	50	84	86	10	10	20	0.58
ESSB 1085	85	12	50	85	87	10	10	20	0.60
ESSB 1088	88	12	55	88	90	10	10	20	0.65
ESSB 1090	90	12	55	90	92	10	10	20	0.67
ESSB 1095	95	12	55	95	97	10	10	20	0.74
ESSB 1096	96	12	60	96	98	10	10	20	0.79
ESSB 10100	100	12	60	100	102	10	10	20	0.82
ESSB 10110	110	12	65	110	112	10	10	20	0.99
ESSB 10120	120	12	68	120	122	10	10	20	1.20

※ 상기 기어의 동력전달표는 74페이지를 참고하십시오.





ESSA

SPUR GEAR

MODULE **1.5**

標準平齒車

●材質 : SM45C ●壓力角 : 20°

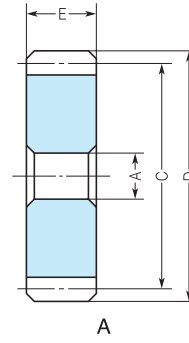

ESSA

■平齒車 (齒幅 15mm)

규격	잇수	내경	피치원직경	치선원직경	치 폭	중량 (kg)
	Z	A _{H7}	C	D	E	
ESSA 1516	16	8	24	27	15	0.04
ESSA 1518	18	10	27	30	15	0.05
ESSA 1520	20	10	30	33	15	0.07
ESSA 1524	24	12	36	39	15	0.11
ESSA 1525	25	12	37.5	40.5	15	0.12
ESSA 1528	28	14	42	45	15	0.15
ESSA 1530	30	14	45	48	15	0.17
ESSA 1532	32	16	48	51	15	0.20
ESSA 1535	35	16	52.5	55.5	15	0.24
ESSA 1536	36	16	54	57	15	0.26
ESSA 1540	40	16	60	63	15	0.31
ESSA 1545	45	16	67.5	70.5	15	0.40
ESSA 1548	48	16	72	75	15	0.46
ESSA 1550	50	16	75	78	15	0.50
ESSA 1555	55	16	82.5	85.5	15	0.56
ESSA 1556	56	16	84	87	15	0.60
ESSA 1560	60	16	90	93	15	0.61
ESSA 1564	64	16	96	99	15	0.85
ESSA 1565	65	16	97.5	100.5	15	0.88
ESSA 1570	70	16	105	108.5	15	1.00
ESSA 1572	72	16	108	111	15	1.10
ESSA 1575	75	16	112.5	115.5	15	1.18
ESSA 1580	80	16	120	123	15	1.20
ESSA 1585	85	16	127.5	130.5	15	1.50
ESSA 1590	90	16	135	138	15	1.68
ESSA 1595	95	16	142.5	145.5	15	1.86
ESSA 15100	100	18	150	153	15	2.10

※ 상기 기어의 동력전달표는 74페이지를 참고하십시오.

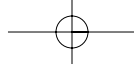

ESSB

SPUR GEAR

MODULE **1.5**

標準平齒車

●材質 : SM45C ●壓力角 : 20°

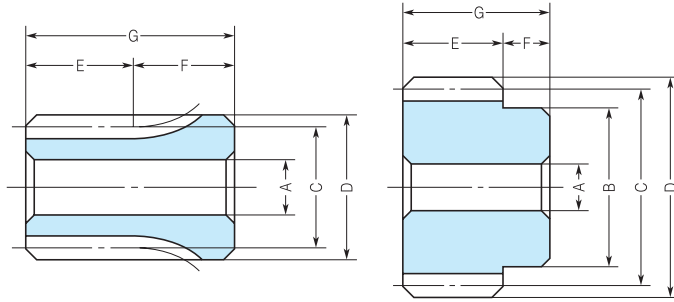

B

■平齒車 (齒幅 18, 17, 15mm)

규격	잇수	내경	보스경	피치원직경	치선원직경	치 폭	보스길이	전장	중량 (kg)
	Z	A _{H7}	B	C	D	E	F	G	
ESSB 1508	8	-	15.96	-	15.96	18	48	90	0.13 (B)
ESSB 1510	10	-	19	-	19	18	48	90	0.19
ESSB 1512	12	8	21	18	21	17	18	35	0.17
ESSB 1513	13	8	22.5	19.5	22.5	17	18	35	0.07
ESSB 1514	14	8	16	21	24	15	12	27	0.04
ESSB 1515	15	8	18	22.5	25.5	15	12	27	0.05
ESSB 1516	16	8	20	24	27	15	12	27	0.07
ESSB 1517	17	8	20	25.5	28.5	15	12	27	0.07
ESSB 1518	18	10	22	27	30	15	12	27	0.08
ESSB 1519	19	10	22	28.5	31.5	15	12	27	0.08
ESSB 1520	20	10	25	30	33	15	12	27	0.11
ESSB 1521	21	10	25	31.5	34.5	15	12	27	0.12
ESSB 1522	22	10	26	33	36	15	12	27	0.12
ESSB 1523	23	10	27	34.5	37.5	15	12	27	0.14
ESSB 1524	24	12	30	36	39	15	12	27	0.16
ESSB 1525	25	12	30	37.5	40.5	15	12	27	0.18
ESSB 1526	26	12	32	39	42	15	12	27	0.21
ESSB 1527	27	12	32	40.5	43.5	15	12	27	0.21
ESSB 1528	28	14	34	42	45	15	12	27	0.22
ESSB 1529	29	14	35	43.5	46.5	15	12	27	0.22
ESSB 1530	30	14	35	45	48	15	12	27	0.24
ESSB 1532	32	16	35	48	51	15	12	27	0.24
ESSB 1534	34	16	40	51	54	15	12	27	0.32
ESSB 1535	35	16	40	52.5	55.5	15	12	27	0.33
ESSB 1536	36	16	40	54	57	15	12	27	0.35
ESSB 1538	38	16	45	57	60	15	12	27	0.41
ESSB 1540	40	16	45	60	63	15	12	27	0.44
ESSB 1542	42	16	45	63	66	15	12	27	0.45
ESSB 1544	44	16	50	66	69	15	12	27	0.55
ESSB 1545	45	16	50	67.5	70.5	15	12	27	0.57
ESSB 1546	46	16	50	69	72	15	12	27	0.59
ESSB 1548	48	16	50	72	75	15	12	27	0.63
ESSB 1550	50	16	50	75	78	15	12	27	0.67
ESSB 1552	52	16	50	78	81	15	12	27	0.71
ESSB 1554	54	16	52	81	84	15	12	27	0.74
ESSB 1555	55	16	52	82.5	85.5	15	12	27	0.81
ESSB 1556	56	16	53	84	87	15	12	27	0.87
ESSB 1558	58	16	55	87	90	15	12	27	0.89
ESSB 1560	60	16	55	90	93	15	12	27	0.94
ESSB 1562	62	16	55	93	96	15	12	27	0.99
ESSB 1564	64	16	60	96	99	15	12	27	1.00
ESSB 1565	65	16	60	97.5	100.5	15	12	27	1.00
ESSB 1566	66	16	60	99	102	15	12	27	1.10
ESSB 1568	68	16	60	102	105	15	12	27	1.20
ESSB 1570	70	16	65	105	108	15	12	27	1.30
ESSB 1572	72	16	65	108	111	15	12	27	1.30
ESSB 1575	75	16	65	112.5	115.5	15	12	27	1.40
ESSB 1576	76	16	65	114	117	15	12	27	1.50
ESSB 1580	80	16	68	120	123	15	12	27	1.60
ESSB 1584	84	16	70	126	129	15	12	27	1.80
ESSB 1585	85	16	70	127.5	130.5	15	12	27	1.80
ESSB 1588	88	16	75	132	135	15	12	27	2.00
ESSB 1590	90	16	75	135	138	15	12	27	2.00
ESSB 1595	95	16	80	142.5	145.5	15	12	27	2.30
ESSB 15100	100	18	85	150	153	15	12	27	2.80
ESSB 15120	120	18	100	180	183	15	12	27	3.70

※ 상기 기어의 동력전달표는 74페이지를 참고하십시오.

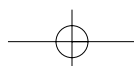



ESSA

SPUR GEAR

MODULE **2**

標準平齒車

●材質 : SM45C ●壓力角 : 20°

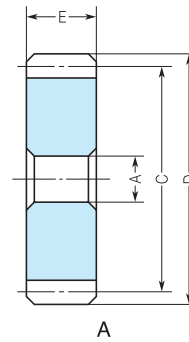

ESSA

■平齒車 (齒幅 20mm)

규격	잇수	내경	피치원직경	치선원직경	치 폭	중량 (kg)
	Z	A _{H7}	C	D	E	
ESSA 2014	14	10	28	32	20	0.09
ESSA 2015	15	10	30	34	20	0.10
ESSA 2016	16	12	32	36	20	0.11
ESSA 2018	18	12	36	40	20	0.14
ESSA 2020	20	12	40	44	20	0.20
ESSA 2024	24	14	48	52	20	0.27
ESSA 2025	25	14	50	54	20	0.29
ESSA 2028	28	16	56	60	20	0.35
ESSA 2030	30	18	60	64	20	0.42
ESSA 2032	32	18	64	68	20	0.49
ESSA 2035	35	18	70	74	20	0.58
ESSA 2036	36	18	72	76	20	0.60
ESSA 2040	40	18	80	84	20	0.80
ESSA 2045	45	18	90	94	20	1.00
ESSA 2048	48	18	96	100	20	1.10
ESSA 2050	50	20	100	104	20	1.20
ESSA 2055	55	20	110	114	20	1.40
ESSA 2056	56	20	112	116	20	1.60
ESSA 2060	60	20	120	124	20	1.90
ESSA 2064	64	20	128	132	20	2.00
ESSA 2065	65	20	130	134	20	2.30
ESSA 2070	70	20	140	144	20	2.60
ESSA 2072	72	20	144	148	20	2.60
ESSA 2075	75	20	150	154	20	2.70
ESSA 2080	80	20	160	164	20	2.90
ESSA 20100	100	22	200	204	20	3.50

※ 상기 기어의 동력전달표는 75페이지를 참고하십시오.



ESSB

SPUR GEAR

MODULE **2**

標準平齒車

●材質 : SM45C ●壓力角 : 20°

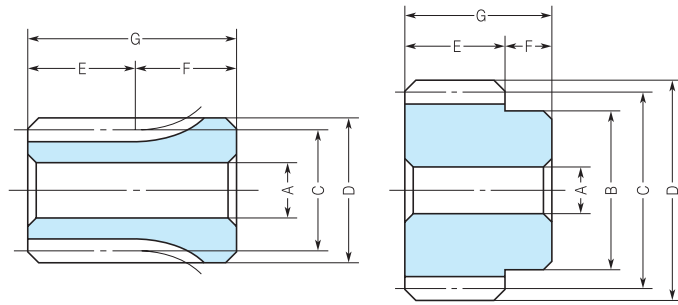

B

■平齒車 (齒幅 22, 20mm)

규격	잇수	내경	보스경	피치원직경	치선원직경	치 폭	보스길이	전장	중량 (kg)
	Z	A _{H7}	B	C	D	E	F	G	
ESSB 2008	8	-	21.28	-	21.28	22	64	118	0.31 (B)
ESSB 2010	10	-	25.33	-	25.33	22	64	118	0.47 (B)
ESSB 2012	12	10	18	24	28	20	14	34	0.06
ESSB 2013	13	10	20	26	30	20	14	34	0.08
ESSB 2014	14	10	21	28	32	20	14	34	0.10
ESSB 2015	15	10	24	30	34	20	14	34	0.13
ESSB 2016	16	12	25	32	36	20	14	34	0.15
ESSB 2017	17	12	27	34	38	20	14	34	0.17
ESSB 2018	18	12	30	36	40	20	14	34	0.20
ESSB 2019	19	12	31	38	42	20	14	34	0.21
ESSB 2020	20	12	33	40	44	20	14	34	0.26
ESSB 2021	21	12	34	42	46	20	14	34	0.26
ESSB 2022	22	12	36	40	48	20	14	34	0.31
ESSB 2023	23	12	37	46	50	20	14	34	0.33
ESSB 2024	24	14	40	48	52	20	14	34	0.38
ESSB 2025	25	14	40	50	54	20	14	34	0.39
ESSB 2026	26	14	42	52	56	20	14	34	0.41
ESSB 2027	27	14	44	54	58	20	14	34	0.47
ESSB 2028	28	16	45	56	60	20	14	34	0.50
ESSB 2029	29	16	46	58	62	20	14	34	0.52
ESSB 2030	30	18	48	60	64	20	14	34	0.56
ESSB 2032	32	18	48	64	68	20	14	34	0.60
ESSB 2034	34	18	50	68	72	20	14	34	0.72
ESSB 2035	35	18	53	70	74	20	14	34	0.76
ESSB 2036	36	18	55	72	76	20	14	34	0.82
ESSB 2038	38	18	58	76	80	20	14	34	0.94
ESSB 2040	40	18	60	80	84	20	14	34	1.10
ESSB 2042	42	18	60	84	88	20	14	34	1.20
ESSB 2044	44	18	60	88	92	20	14	34	1.30
ESSB 2045	45	18	60	90	94	20	14	34	1.30
ESSB 2046	46	18	60	92	96	20	14	34	1.30
ESSB 2048	48	18	62	96	100	20	14	34	1.40
ESSB 2050	50	20	62	100	104	20	14	34	1.50
ESSB 2052	52	20	65	104	108	20	14	34	1.60
ESSB 2054	54	20	65	108	112	20	14	34	1.70
ESSB 2055	55	20	65	110	114	20	14	34	1.80
ESSB 2056	56	20	65	112	116	20	14	34	1.80
ESSB 2058	58	20	65	116	120	20	14	34	1.90
ESSB 2060	60	20	68	120	124	20	14	34	2.00
ESSB 2062	62	20	68	124	128	20	14	34	2.10
ESSB 2064	64	20	70	128	132	20	14	34	2.20
ESSB 2065	65	20	75	130	134	20	14	34	2.50
ESSB 2066	66	20	75	132	136	20	14	34	2.60
ESSB 2068	68	20	75	136	140	20	14	34	2.70
ESSB 2070	70	20	80	140	144	20	14	34	2.80
ESSB 2072	72	20	80	144	148	20	14	34	2.90
ESSB 2075	75	20	85	150	154	20	14	34	3.20
ESSB 2076	76	20	85	152	156	20	14	34	3.30
ESSB 2080	80	20	90	160	164	20	14	34	3.80
ESSB 2084	84	20	95	168	172	20	14	34	4.20
ESSB 2085	85	20	95	170	174	20	14	34	4.30
ESSB 2088	88	20	100	176	180	20	14	34	4.70
ESSB 2090	90	20	100	180	184	20	14	34	4.80
ESSB 2095	95	20	100	190	194	20	14	34	5.20
ESSB 20100	100	22	110	200	204	20	14	34	5.90
ESSB 20120	120	22	130	240	244	20	14	34	8.50

※ 상기 기어의 동력전달표는 75페이지를 참고하십시오.





ESSA

SPUR GEAR

MODULE **2.5**

標準平齒車

●材質 : SM45C ●壓力角 : 20°

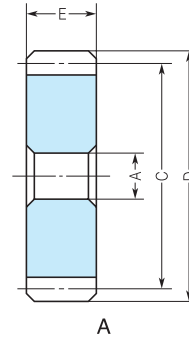

ESSA

■平齒車 (齒幅 25mm)

규격	잇수	내경	피치원직경	치선원직경	치 폭	중량 (kg)
	Z	A _{H7}	C	D	E	
ESSA 2514	14	12	35	40	25	0.16
ESSA 2515	15	12	37.5	42.5	25	0.18
ESSA 2516	16	12	40	45	25	0.23
ESSA 2518	18	12	45	50	25	0.27
ESSA 2520	20	14	50	55	25	0.37
ESSA 2524	24	18	60	65	25	0.52
ESSA 2525	25	18	62.5	67.5	25	0.57
ESSA 2528	28	18	70	75	25	0.71
ESSA 2530	30	20	75	80	25	0.80
ESSA 2532	32	20	80	85	25	0.98
ESSA 2535	35	20	87.5	92.5	25	1.10
ESSA 2536	36	20	90	95	25	1.20
ESSA 2540	40	20	100	105	25	1.50
ESSA 2545	45	20	112.5	117.5	25	1.90
ESSA 2548	48	20	120	125	25	2.20
ESSA 2550	50	22	125	130	25	2.40
ESSA 2555	55	22	137.5	142.5	25	2.90
ESSA 2556	56	22	140	145	25	2.90
ESSA 2560	60	22	150	155	25	3.40
ESSA 2564	64	22	160	165	25	3.40
ESSA 2565	65	22	162.5	167.5	25	4.00
ESSA 2570	70	22	175	180	25	4.70
ESSA 2572	72	22	180	185	25	5.00
ESSA 2575	75	22	187.5	192.5	25	5.50
ESSA 2580	80	22	200	205	25	6.20

※ 상기 기어의 동력전달표는 75페이지를 참고하십시오.



ESSB

SPUR GEAR

MODULE **2.5**

標準平齒車

●材質 : SM45C ●壓力角 : 20°

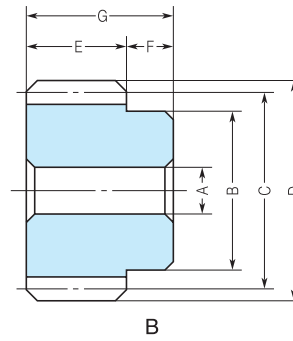

■平齒車 (齒幅 28, 25mm)

규격	잇수	내경	보스경	피치원직경	치선원직경	치 폭	보스길이	전장	중량 (kg)
	Z	A _{H7}	B	C	D	E	F	G	
ESSB 2508	8	-	26.59	-	26.59	28	80	148	0.68
ESSB 2510	10	-	31.66	-	31.66	28	80	148	0.84
ESSB 2512	12	12	23	30	35	25	16	41	0.16
ESSB 2513	13	12	25	32.5	37.5	25	16	41	0.18
ESSB 2514	14	12	26	35	40	25	16	41	0.21
ESSB 2515	15	12	30	37.5	42.5	25	16	41	0.26
ESSB 2516	16	12	32	40	45	25	16	41	0.31
ESSB 2517	17	12	34	42.5	47.5	25	16	41	0.35
ESSB 2518	18	12	36	45	50	25	16	41	0.40
ESSB 2519	19	14	40	47.5	52.5	25	16	41	0.45
ESSB 2520	20	14	42	50	55	25	16	41	0.52
ESSB 2521	21	14	44	52.5	57.5	25	16	41	0.55
ESSB 2522	22	14	45	55	60	25	16	41	0.62
ESSB 2523	23	14	47	57.5	62.5	25	16	41	0.66
ESSB 2524	24	18	50	60	65	25	16	41	0.70
ESSB 2525	25	18	50	62.5	67.5	25	16	41	0.74
ESSB 2526	26	18	52	65	70	25	16	41	0.84
ESSB 2527	27	18	54	67.5	72.5	25	16	41	0.88
ESSB 2528	28	18	56	70	75	25	16	41	0.96
ESSB 2529	29	18	58	72.5	77.5	25	16	41	1.00
ESSB 2530	30	20	60	75	80	25	16	41	1.10
ESSB 2532	32	20	70	80	85	25	16	41	1.40
ESSB 2534	34	20	70	85	90	25	16	41	1.50
ESSB 2535	35	20	70	87.5	92.5	25	16	41	1.60
ESSB 2536	36	20	70	90	95	25	16	41	1.70
ESSB 2538	38	20	70	95	100	25	16	41	1.80
ESSB 2540	40	20	75	100	105	25	16	41	2.00
ESSB 2542	42	20	75	105	110	25	16	41	2.00
ESSB 2544	44	20	80	110	115	25	16	41	2.10
ESSB 2545	45	20	80	112.5	117.5	25	16	41	2.10
ESSB 2546	46	20	80	115	120	25	16	41	2.20
ESSB 2548	48	20	80	120	125	25	16	41	2.60
ESSB 2550	50	22	90	125	130	25	16	41	3.00
ESSB 2552	52	22	90	130	135	25	16	41	3.20
ESSB 2554	54	22	90	135	140	25	16	41	3.40
ESSB 2555	55	22	90	137.5	142.5	25	16	41	3.50
ESSB 2556	56	22	90	140	145	25	16	41	3.60
ESSB 2558	58	22	90	145	150	25	16	41	3.70
ESSB 2560	60	22	95	150	155	25	16	41	4.10
ESSB 2562	62	22	95	155	160	25	16	41	4.30
ESSB 2564	64	22	95	160	165	25	16	41	4.70
ESSB 2565	65	22	95	162.5	167.5	25	16	41	4.90
ESSB 2566	66	22	95	165	170	25	16	41	5.00
ESSB 2568	68	22	100	170	175	25	16	41	5.60
ESSB 2570	70	22	100	175	180	25	16	41	5.70
ESSB 2572	72	22	100	180	185	25	16	41	6.10
ESSB 2575	75	22	100	187.5	192.5	25	16	41	6.30
ESSB 2576	76	22	100	190	195	25	16	41	6.40
ESSB 2580	80	22	110	200	205	25	16	41	7.40
ESSB 2590	90	22	120	225	230	25	16	41	9.20
ESSB 25100	100	25	130	250	255	25	16	41	10.00
ESSB 25120	120	25	140	300	305	25	16	41	15.7

※ 상기 기어의 동력전달표는 75페이지를 참고하십시오.





ESSA

SPUR GEAR

MODULE **3**

標準平齒車

●材質 : SM45C ●壓力角 : 20°

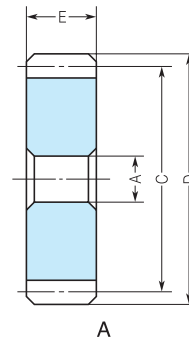

ESSA

■平齒車 (齒幅 30mm)

규격	잇수	내경	피치원직경	치선원직경	치 폭	중량 (kg)
	Z	A _{H7}	C	D	E	
ESSA 3014	14	15	42	48	30	0.28
ESSA 3015	15	15	45	51	30	0.33
ESSA 3016	16	16	48	54	30	0.38
ESSA 3018	18	16	54	60	30	0.49
ESSA 3020	20	18	60	66	30	0.63
ESSA 3024	24	18	72	78	30	0.95
ESSA 3025	25	18	75	81	30	1.0
ESSA 3026	26	20	78	84	30	1.0
ESSA 3027	27	20	81	87	30	1.1
ESSA 3028	28	20	84	90	30	1.2
ESSA 3029	29	20	87	93	30	1.4
ESSA 3030	30	20	90	96	30	1.6
ESSA 3032	32	20	96	102	30	1.6
ESSA 3035	35	22	105	111	30	1.9
ESSA 3036	36	22	108	114	30	2.1
ESSA 3040	40	22	120	126	30	2.6
ESSA 3045	45	22	135	141	30	3.3
ESSA 3048	48	22	144	150	30	3.8
ESSA 3050	50	22	150	156	30	4.0
ESSA 3055	55	22	165	171	30	4.9
ESSA 3056	56	25	168	174	30	5.3
ESSA 3060	60	25	180	186	30	6.0
ESSA 3064	64	25	192	198	30	6.9
ESSA 3065	65	25	195	201	30	7.1
ESSA 3070	70	25	210	216	30	11
ESSA 3075	75	25	225	231	30	19
ESSA 3080	80	25	240	246	30	20

※ 상기 기어의 동력전달효는 76페이지를 참고하십시오.



ESSB

SPUR GEAR

MODULE **3**

標準平齒車

●材質 : SM45C ●壓力角 : 20°

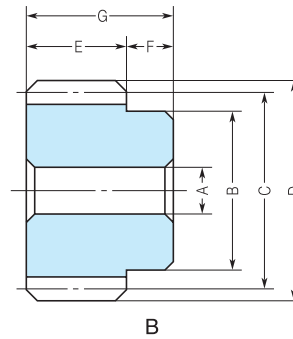

■ 平齒車 (齒幅 35, 30mm)

규격	잇수	내경	보스경	피치원직경	치선원직경	치 폭	보스길이	전장	중량 (kg)
	Z	A _{H7}	B	C	D	E	F	G	
ESSB 3008	8	-	31.91	-	31.91	35	85	160	0.93
ESSB 3010	10	-	37.99	-	37.99	35	85	160	1.33
ESSB 3012	12	15	27	36	42	30	18	48	0.24
ESSB 3013	13	15	30	39	45	30	18	48	0.32
ESSB 3014	14	15	32	42	48	30	18	48	0.36
ESSB 3015	15	15	35	45	51	30	18	48	0.44
ESSB 3016	16	16	40	48	54	30	18	48	0.58
ESSB 3017	17	16	40	51	57	30	18	48	0.58
ESSB 3018	18	16	44	54	60	30	18	48	0.66
ESSB 3019	19	16	46	57	63	30	18	48	0.82
ESSB 3020	20	18	50	60	66	30	18	48	0.84
ESSB 3021	21	18	52	63	69	30	18	48	0.92
ESSB 3022	22	18	54	66	72	30	18	48	0.98
ESSB 3023	23	18	56	69	75	30	18	48	1.0
ESSB 3024	24	18	58	72	78	30	18	48	1.1
ESSB 3025	25	18	60	75	81	30	18	48	1.3
ESSB 3026	26	20	65	78	84	30	18	48	1.5
ESSB 3027	27	20	65	81	87	30	18	48	1.6
ESSB 3028	28	20	70	84	90	30	18	48	1.7
ESSB 3029	29	20	75	87	93	30	18	48	1.9
ESSB 3030	30	20	75	90	96	30	18	48	2.0
ESSB 3032	32	20	75	96	102	30	18	48	2.2
ESSB 3034	34	20	80	102	108	30	18	48	2.6
ESSB 3035	35	22	80	105	111	30	18	48	2.7
ESSB 3036	36	22	80	108	114	30	18	48	2.7
ESSB 3038	38	22	80	114	120	30	18	48	2.8
ESSB 3040	40	22	85	120	126	30	18	48	3.3
ESSB 3042	42	22	85	126	132	30	18	48	3.5
ESSB 3044	44	22	85	132	138	30	18	48	3.8
ESSB 3045	45	22	85	135	141	30	18	48	3.9
ESSB 3046	46	22	85	138	144	30	18	48	4.0
ESSB 3048	48	22	85	144	150	30	18	48	4.4
ESSB 3050	50	22	85	150	156	30	18	48	4.9
ESSB 3052	52	22	85	156	162	30	18	48	5.2
ESSB 3054	54	22	90	162	168	30	18	48	5.8
ESSB 3055	55	22	90	165	171	30	18	48	5.9
ESSB 3056	56	25	95	168	174	30	18	48	6.2
ESSB 3058	58	25	95	174	180	30	18	48	7.0
ESSB 3060	60	25	100	180	186	30	18	48	7.1
ESSB 3062	62	25	100	186	192	30	18	48	7.3
ESSB 3064	64	25	110	192	198	30	18	48	8.1
ESSB 3065	65	25	110	195	201	30	18	48	8.4
ESSB 3066	66	25	110	198	204	30	18	48	8.5
ESSB 3068	68	25	110	204	210	30	18	48	8.7
ESSB 3070	70	25	110	210	216	30	18	48	9.4
ESSB 3072	72	25	120	216	222	30	18	48	10
ESSB 3075	75	25	120	225	231	30	18	48	11
ESSB 3076	76	25	120	228	234	30	18	48	11.5
ESSB 3080	80	25	130	240	246	30	18	48	12
ESSB 3090	90	25	130	270	276	30	18	48	15.2
ESSB 30100	100	28	140	300	306	30	18	48	18
ESSB 30120	120	28	150	360	366	30	18	48	26.0

※ 상기 기어의 동력전달표는 76페이지를 참고하십시오.





ESSA

SPUR GEAR

MODULE **4**

標準平齒車

●材質 : SM45C ●壓力角 : 20°

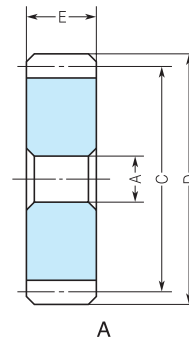

ESSA

■平齒車 (齒幅 40mm)

규격	잇수	내경	피치원직경	치선원직경	치 폭	중량 (kg)
	Z	A _{H7}	C	D	E	
ESSA 4020	20	22	80	88	40	1.5
ESSA 4024	24	22	96	104	40	2.2
ESSA 4025	25	25	100	108	40	2.4
ESSA 4026	26	25	104	112	40	2.6
ESSA 4027	27	25	108	116	40	2.8
ESSA 4028	28	25	112	120	40	3.0
ESSA 4029	29	25	116	124	40	3.4
ESSA 4030	30	25	120	128	40	3.4
ESSA 4032	32	25	128	136	40	3.9
ESSA 4035	35	28	140	148	40	4.7
ESSA 4036	36	28	144	152	40	4.9
ESSA 4040	40	28	160	168	40	6.2
ESSA 4045	45	28	180	188	40	7.8
ESSA 4048	48	28	192	200	40	9.0
ESSA 4050	50	28	200	208	40	10.0
ESSA 4055	55	28	220	228	40	12.0
ESSA 4056	56	30	224	232	40	13.0
ESSA 4060	60	30	240	248	40	15.0

※ 상기 기어의 동력전달표는 76페이지를 참고하십시오.



ESSB

SPUR GEAR

MODULE **4**

標準平齒車

●材質 : SM45C ●壓力角 : 20°

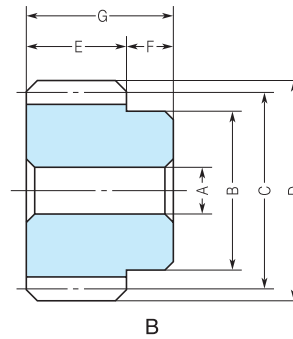

■ 平齒車 (齒幅 40mm)

규격	잇수	내경	보스경	피치원직경	치선원직경	치 폭	보스길이	전장	중량 (kg)
	Z	A _{H7}	B	C	D	E	F	G	
ESSB 4012	12	18	36	48	56	40	21	61	0.59
ESSB 4013	13	18	40	52	60	40	21	61	0.72
ESSB 4014	14	18	44	56	64	40	21	61	0.88
ESSB 4015	15	18	48	60	68	40	21	61	1.0
ESSB 4016	16	20	52	64	72	40	21	61	1.2
ESSB 4017	17	20	56	68	76	40	21	61	1.4
ESSB 4018	18	20	60	72	80	40	21	61	1.5
ESSB 4019	19	20	63	76	84	40	21	61	1.8
ESSB 4020	20	22	66	80	88	40	21	61	1.9
ESSB 4021	21	22	70	84	92	40	21	61	2.2
ESSB 4022	22	22	72	88	96	40	21	61	2.3
ESSB 4023	23	22	75	92	100	40	21	61	2.6
ESSB 4024	24	22	78	96	104	40	21	61	2.8
ESSB 4025	25	25	84	100	108	40	21	61	3.2
ESSB 4026	26	25	87	104	112	40	21	61	3.5
ESSB 4027	27	25	90	108	116	40	21	61	3.7
ESSB 4028	28	25	95	112	120	40	21	61	4.0
ESSB 4029	29	25	95	116	124	40	21	61	4.1
ESSB 4030	30	25	100	120	128	40	21	61	4.6
ESSB 4032	32	25	100	128	136	40	21	61	5.1
ESSB 4034	34	25	100	136	144	40	21	61	5.7
ESSB 4035	35	28	100	140	148	40	21	61	5.9
ESSB 4036	36	28	100	144	152	40	21	61	6.2
ESSB 4038	38	28	100	152	160	40	21	61	6.7
ESSB 4040	40	28	100	160	168	40	21	61	7.4
ESSB 4042	42	28	100	168	176	40	21	61	8.1
ESSB 4044	44	28	100	176	184	40	21	61	8.8
ESSB 4045	45	28	100	180	188	40	21	61	9.0
ESSB 4046	46	28	100	184	192	40	21	61	9.2
ESSB 4048	48	28	110	192	200	40	21	61	11
ESSB 4050	50	28	110	200	208	40	21	61	12
ESSB 4052	52	28	110	208	216	40	21	61	12
ESSB 4054	54	28	110	216	224	40	21	61	13
ESSB 4055	55	28	120	220	228	40	21	61	13
ESSB 4056	56	30	120	224	232	40	21	61	14
ESSB 4058	58	30	120	232	240	40	21	61	14
ESSB 4060	60	30	130	240	248	40	21	61	16
ESSB 4062	62	30	130	248	256	40	21	61	17
ESSB 4064	64	30	140	256	264	40	21	61	18
ESSB 4065	65	30	140	260	268	40	21	61	19
ESSB 4066	66	30	140	264	272	40	21	61	20
ESSB 4068	68	30	150	272	280	40	21	61	21
ESSB 4070	70	30	150	280	288	40	21	61	22
ESSB 4080	80	30	150	320	328	40	21	61	28

* 상기 기어의 동력전달표는 76페이지를 참고하십시오.





ESSA

SPUR GEAR

MODULE **5**

標準平齒車

●材質 : SM45C ●壓力角 : 20°

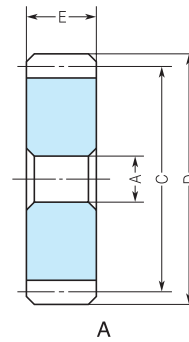

ESSA

■平齒車 (齒幅 50mm)

규격	잇수	내경	피치원직경	치선원직경	치 폭	중량 (kg)
	Z	A _{H7}	C	D	E	
ESSA 5020	20	25	100	110	50	3.1
ESSA 5021	21	28	105	115	50	3.2
ESSA 5022	22	28	110	120	50	3.8
ESSA 5023	23	28	115	125	50	4.1
ESSA 5024	24	28	120	130	50	4.3
ESSA 5025	25	28	125	135	50	4.6
ESSA 5026	26	28	130	140	50	5.0
ESSA 5027	27	28	135	145	50	5.4
ESSA 5028	28	30	140	150	50	5.8
ESSA 5029	29	30	145	155	50	6.2
ESSA 5030	30	30	150	160	50	6.7
ESSA 5032	32	30	160	170	50	7.8
ESSA 5035	35	30	175	185	50	9.4
ESSA 5036	36	30	180	190	50	9.8
ESSA 5040	40	30	200	210	50	12
ESSA 5045	45	35	225	235	50	15
ESSA 5048	48	35	240	250	50	17
ESSA 5050	50	35	250	260	50	19

※ 상기 기어의 동력전달표는 76페이지를 참고하십시오.



ESSB

SPUR GEAR

MODULE **5**

標準平齒車

●材質: SM45C ●壓力角: 20°

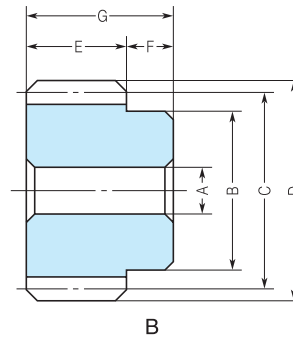

■平齒車 (齒幅 50mm)

규격	잇수	내경	보스경	피치원직경	치선원직경	치 폭	보스길이	전장	중량 (kg)
	Z	A _{H7}	B	C	D	E	F	G	
ESSB 5012	12	20	45	60	70	50	24	74	1.2
ESSB 5013	13	20	50	65	75	50	24	74	1.4
ESSB 5014	14	22	55	70	80	50	24	74	1.7
ESSB 5015	15	22	60	75	85	50	24	74	2.0
ESSB 5016	16	25	65	80	90	50	24	74	2.4
ESSB 5017	17	25	70	85	95	50	24	74	2.6
ESSB 5018	18	25	75	90	100	50	24	74	3.0
ESSB 5019	19	25	78	95	105	50	24	74	3.4
ESSB 5020	20	25	82	100	110	50	24	74	3.8
ESSB 5021	21	28	90	105	115	50	24	74	4.3
ESSB 5022	22	28	95	110	120	50	24	74	4.7
ESSB 5023	23	28	100	115	125	50	24	74	5.2
ESSB 5024	24	28	100	120	130	50	24	74	5.6
ESSB 5025	25	28	105	125	135	50	24	74	6.1
ESSB 5026	26	28	110	130	140	50	24	74	6.7
ESSB 5027	27	28	110	135	145	50	24	74	7.1
ESSB 5028	28	30	110	140	150	50	24	74	7.4
ESSB 5029	29	30	110	145	155	50	24	74	7.9
ESSB 5030	30	30	120	150	160	50	24	74	8.8
ESSB 5032	32	30	120	160	170	50	24	74	9.9
ESSB 5034	34	30	120	170	180	50	24	74	11
ESSB 5035	35	30	120	175	185	50	24	74	11
ESSB 5036	36	30	120	180	190	50	24	74	12
ESSB 5038	38	30	120	190	200	50	24	74	13
ESSB 5040	40	30	120	200	210	50	24	74	14
ESSB 5042	42	30	120	210	220	50	24	74	16
ESSB 5044	44	30	120	220	230	50	24	74	17
ESSB 5045	45	35	130	225	235	50	24	74	18
ESSB 5046	46	35	130	230	240	50	24	74	18
ESSB 5048	48	35	130	240	250	50	24	74	20
ESSB 5050	50	35	140	250	260	50	24	74	23
ESSB 5052	52	35	140	260	270	50	24	74	24
ESSB 5054	54	35	140	270	280	50	24	74	25
ESSB 5055	55	35	140	275	285	50	24	74	26
ESSB 5056	56	35	150	280	290	50	24	74	28
ESSB 5058	58	35	150	290	300	50	24	74	29
ESSB 5060	60	35	150	300	310	50	24	74	31

※ 상기 기어의 동력전달표는 77페이지를 참고하십시오.





ESSA

SPUR GEAR

MODULE 6

標準平齒車

●材質 : SM45C ●壓力角 : 20°

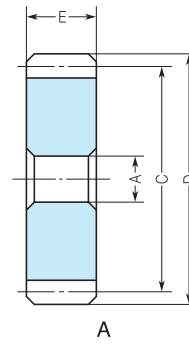

ESSA

■平齒車 (齒幅 60mm)

규격	잇수	내경	피치원직경	치선원직경	치 폭	중량 (kg)
	Z	A _{H7}	C	D	E	
ESSA 6021	21	30	126	138	60	4.9
ESSA 6022	22	30	132	144	60	5.4
ESSA 6023	23	30	138	150	60	5.9
ESSA 6024	24	30	144	156	60	6.4
ESSA 6025	25	30	150	162	60	6.6
ESSA 6026	26	32	156	168	60	6.9
ESSA 6027	27	32	162	174	60	7.3
ESSA 6028	28	32	168	180	60	7.7
ESSA 6029	29	32	174	186	60	8.1
ESSA 6030	30	32	180	192	60	8.6
ESSA 6032	32	35	192	204	60	9.1
ESSA 6035	35	35	210	222	60	10
ESSA 6036	36	35	216	228	60	10
ESSA 6040	40	35	240	252	60	12

※ 상기 기어의 동력전달표는 77페이지를 참고하십시오.



ESB

SPUR GEAR

MODULE **6**

標準平齒車

●材質 : SM45C ●壓力角 : 20°

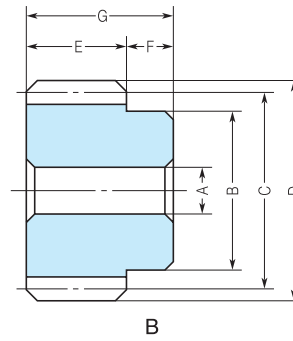

■ 平齒車 (齒幅 60mm)

규격	잇수	내경	보스경	피치원직경	치선원직경	치 폭	보스길이	전장	중량 (kg)
	Z	A _{H7}	B	C	D	E	F	G	
ESB 6012	12	25	54	72	84	60	28	88	2.1
ESB 6013	13	25	60	78	90	60	28	88	2.5
ESB 6014	14	25	66	84	96	60	28	88	3.0
ESB 6015	15	25	72	90	102	60	28	88	3.5
ESB 6016	16	28	78	96	108	60	28	88	3.9
ESB 6017	17	28	84	102	114	60	28	88	4.6
ESB 6018	18	28	90	108	120	60	28	88	5.2
ESB 6019	19	28	96	114	126	60	28	88	5.8
ESB 6020	20	28	100	120	132	60	28	88	6.5
ESB 6021	21	30	105	126	138	60	28	88	7.1
ESB 6022	22	30	110	132	144	60	28	88	8.0
ESB 6023	23	30	115	138	150	60	28	88	8.8
ESB 6024	24	30	120	144	156	60	28	88	9.6
ESB 6025	25	30	120	150	162	60	28	88	10
ESB 6026	26	32	120	156	168	60	28	88	11
ESB 6027	27	32	130	162	174	60	28	88	12
ESB 6028	28	32	130	168	180	60	28	88	12
ESB 6030	30	32	130	180	192	60	28	88	13
ESB 6032	32	32	130	192	204	60	28	88	16
ESB 6034	34	32	130	204	216	60	28	88	18
ESB 6035	35	32	130	210	222	60	28	88	19
ESB 6036	36	32	130	216	228	60	28	88	20
ESB 6038	38	32	130	228	240	60	28	88	22
ESB 6040	40	35	140	240	252	60	28	88	24
ESB 6042	42	35	140	252	264	60	28	88	26
ESB 6044	44	35	140	264	276	60	28	88	27
ESB 6045	45	35	140	270	282	60	28	88	28
ESB 6046	46	35	140	276	288	60	28	88	31
ESB 6048	48	35	150	288	300	60	28	88	34
ESB 6050	50	35	150	300	312	60	28	88	37

※ 상기 기어의 동력전달표는 77페이지를 참고하십시오.





ESSA

SPUR GEAR

MODULE **8**

標準平齒車

● 材質 : SM45C ● 壓力角 : 20°

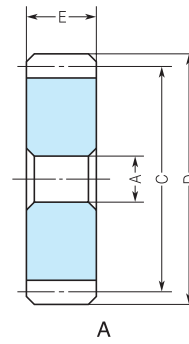
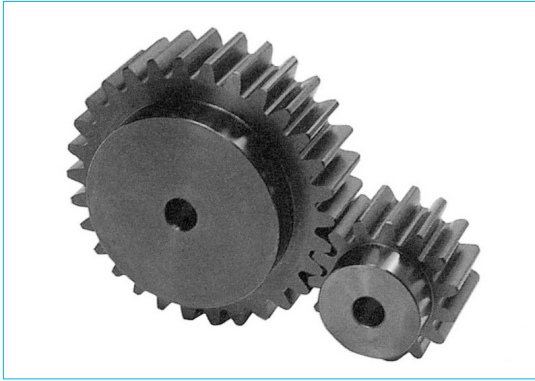

ESSA

■ 平齒車 (齒幅 80mm)

규 격	잇 수	내 경	피치원직경	치선원직경	치 폭	중 량 (kg)
	Z	A_{H7}	C	D	E	
ESSA 8021	21	38	168	184	80	13
ESSA 8022	22	38	176	192	80	14
ESSA 8023	23	38	184	200	80	15
ESSA 8024	24	38	192	208	80	17
ESSA 8025	25	38	200	216	80	19
ESSA 8026	26	40	208	224	80	20
ESSA 8027	27	40	216	232	80	22
ESSA 8028	28	40	224	240	80	23
ESSA 8029	29	40	232	248	80	26
ESSA 8030	30	42	240	256	80	27

※ 상기 기어의 동력전달표는 77페이지를 참고하십시오.



ESSB

SPUR GEAR

MODULE **8**

標準平齒車

● 材質 : SM45C ● 壓力角 : 20°

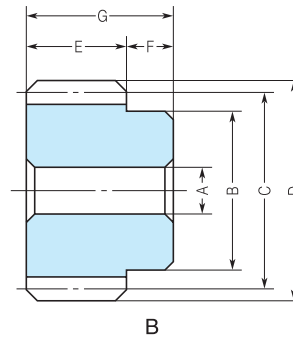

■ 平齒車 (齒幅 80mm)

규격	잇수	내경	보스경	피치원직경	치선원직경	치 폭	보스길이	전장	중량 (kg)
	Z	A _{H7}	B	C	D	E	F	G	
ESSB 8012	12	30	72	96	112	80	32	112	5.0
ESSB 8013	13	30	80	104	120	80	32	112	6.0
ESSB 8014	14	30	88	112	128	80	32	112	6.8
ESSB 8015	15	30	96	120	136	80	32	112	6.8
ESSB 8016	16	32	104	128	144	80	32	112	8.6
ESSB 8017	17	32	112	136	152	80	32	112	9.6
ESSB 8018	18	35	120	144	160	80	32	112	11
ESSB 8019	19	35	120	152	168	80	32	112	13
ESSB 8020	20	35	120	160	176	80	32	112	15
ESSB 8021	21	38	130	168	184	80	32	112	17
ESSB 8022	22	38	130	176	192	80	32	112	19
ESSB 8023	23	38	130	184	200	80	32	112	22
ESSB 8024	24	38	130	192	208	80	32	112	23
ESSB 8025	25	38	140	200	216	80	32	112	25
ESSB 8026	26	40	140	208	224	80	32	112	25
ESSB 8027	27	40	140	216	232	80	32	112	26
ESSB 8028	28	40	140	224	240	80	32	112	28
ESSB 8030	30	42	150	240	256	80	32	112	32

※ 상기 기어의 동력전달표는 77페이지를 참고하십시오.



標準平齒車 許容傳達標準動力表(kW)

※ 아래 제품의 허용전달동력표는 재질이 SM45C 제품으로 동일한 모듈 및 잇수인 조건에서 ESSA, ESSB는 동등한 강도 및 동력전달이 가능합니다.

ESS 1.0 平齒車

rpm 규격	rpm					
	30	100	300	600	900	1200
ESS1- 08	0.004	0.008	0.024	0.04	0.07	0.09
ESS1- 10	0.005	0.01	0.03	0.06	0.09	0.11
ESS1- 12	0.008	0.02	0.06	0.12	0.13	0.14
ESS1- 13	0.009	0.03	0.08	0.16	0.24	0.32
ESS1- 14	0.01	0.033	0.10	0.19	0.28	0.37
ESS1- 15	0.010	0.036	0.10	0.21	0.32	0.39
ESS1- 16	0.011	0.039	0.11	0.23	0.35	0.43
ESS1- 17	0.013	0.043	0.13	0.26	0.39	0.43
ESS1- 18	0.014	0.047	0.14	0.28	0.42	0.47
ESS1- 19	0.015	0.051	0.15	0.30	0.45	0.51
ESS1- 20	0.016	0.054	0.16	0.32	0.46	0.54
ESS1- 21	0.017	0.058	0.17	0.35	0.48	0.58
ESS1- 22	0.018	0.062	0.18	0.37	0.49	0.62
ESS1- 23	0.019	0.066	0.19	0.39	0.50	0.66
ESS1- 24	0.021	0.070	0.21	0.42	0.52	0.70
ESS1- 25	0.022	0.074	0.22	0.44	0.55	0.74
ESS1- 26	0.023	0.078	0.23	0.46	0.58	0.78
ESS1- 27	0.024	0.082	0.24	0.49	0.61	0.82
ESS1- 28	0.025	0.086	0.25	0.51	0.64	0.86
ESS1- 29	0.027	0.090	0.27	0.54	0.67	0.90
ESS1- 30	0.028	0.094	0.28	0.55	0.70	0.94
ESS1- 32	0.030	0.10	0.30	0.56	0.76	1.02
ESS1- 34	0.033	0.11	0.33	0.58	0.82	1.10
ESS1- 35	0.034	0.11	0.34	0.60	0.85	1.14
ESS1- 36	0.035	0.11	0.35	0.61	0.88	1.18
ESS1- 38	0.037	0.12	0.37	0.63	0.94	1.26
ESS1- 40	0.040	0.13	0.40	0.67	1.00	1.34
ESS1- 42	0.042	0.14	0.42	0.71	1.07	1.42
ESS1- 44	0.045	0.15	0.45	0.75	1.13	1.50
ESS1- 45	0.046	0.15	0.46	0.77	1.16	1.54
ESS1- 46	0.047	0.15	0.47	0.79	1.19	1.55
ESS1- 48	0.050	0.16	0.50	0.83	1.25	1.59
ESS1- 50	0.052	0.17	0.52	0.87	1.31	1.62
ESS1- 52	0.055	0.18	0.55	0.91	1.37	1.69
ESS1- 54	0.057	0.19	0.57	0.96	1.44	1.77
ESS1- 55	0.058	0.19	0.58	0.98	1.47	1.81
ESS1- 56	0.060	0.20	0.59	1.00	1.50	1.85
ESS1- 58	0.062	0.20	0.60	1.04	1.56	1.92
ESS1- 60	0.065	0.21	0.61	1.08	1.61	2.00
ESS1- 62	0.067	0.22	0.62	1.12	1.62	2.08
ESS1- 64	0.070	0.23	0.63	1.16	1.64	2.15
ESS1- 65	0.071	0.23	0.64	1.18	1.67	2.19
ESS1- 66	0.072	0.24	0.65	1.21	1.69	2.23
ESS1- 68	0.075	0.25	0.66	1.25	1.73	2.31
ESS1- 70	0.077	0.25	0.67	1.29	1.79	2.38
ESS1- 72	0.080	0.26	0.68	1.33	1.84	2.46
ESS1- 75	0.083	0.27	0.69	1.39	1.93	2.57
ESS1- 76	0.085	0.28	0.70	1.41	1.96	2.58
ESS1- 80	0.090	0.30	0.75	1.50	2.08	2.62
ESS1- 84	0.095	0.31	0.79	1.58	2.19	2.72
ESS1- 85	0.096	0.32	0.80	1.60	2.22	2.75
ESS1- 88	0.10	0.33	0.83	1.67	2.31	2.86
ESS1- 90	0.10	0.34	0.85	1.71	2.37	2.93
ESS1- 95	0.10	0.36	0.90	1.81	2.51	3.11
ESS1- 96	0.11	0.36	0.91	1.69	2.54	3.15
ESS1-100	0.11	0.38	0.96	1.77	2.66	3.29
ESS1-110	0.12	0.42	1.06	1.97	2.74	3.65
ESS1-120	0.14	0.46	1.17	2.16	3.01	4.02

ESS 1.5 平齒車

rpm 규격	rpm					
	30	100	300	600	900	1200
ESS1.5- 08	0.01	0.056	0.16	0.33	0.50	0.56
ESS1.5- 10	0.019	0.064	0.19	0.50	0.58	0.64
ESS1.5- 12	0.025	0.084	0.25	0.57	0.75	0.84
ESS1.5- 13	0.028	0.095	0.28	0.58	0.86	0.95
ESS1.5- 14	0.032	0.10	0.32	0.64	0.89	1.07
ESS1.5- 15	0.035	0.11	0.35	0.71	0.96	1.19
ESS1.5- 16	0.039	0.13	0.39	0.79	0.98	1.31
ESS1.5- 17	0.043	0.14	0.43	0.86	1.08	1.44
ESS1.5- 18	0.046	0.15	0.46	0.93	1.17	1.56
ESS1.5- 19	0.050	0.16	0.50	1.01	1.26	1.69
ESS1.5- 20	0.054	0.18	0.54	1.03	1.36	1.81
ESS1.5- 21	0.058	0.19	0.58	1.08	1.45	1.94
ESS1.5- 22	0.062	0.20	0.62	1.09	1.55	2.07
ESS1.5- 23	0.065	0.21	0.65	1.16	1.64	2.19
ESS1.5- 24	0.069	0.23	0.69	1.20	1.74	2.32
ESS1.5- 25	0.073	0.24	0.73	1.22	1.84	2.45
ESS1.5- 26	0.077	0.25	0.77	1.29	1.94	2.58
ESS1.5- 27	0.081	0.27	0.82	1.36	2.04	2.72
ESS1.5- 28	0.085	0.28	0.85	1.42	2.13	2.85
ESS1.5- 29	0.089	0.29	0.89	1.49	2.23	2.98
ESS1.5- 30	0.093	0.31	0.93	1.55	2.33	3.11
ESS1.5- 32	0.10	0.33	1.01	1.69	2.53	3.12
ESS1.5- 34	0.10	0.36	1.09	1.82	2.73	3.36
ESS1.5- 35	0.11	0.37	1.13	1.89	2.83	3.49
ESS1.5- 36	0.11	0.39	1.17	1.95	2.93	3.61
ESS1.5- 38	0.12	0.41	1.24	2.09	3.13	3.86
ESS1.5- 40	0.13	0.44	1.25	2.22	3.34	4.11
ESS1.5- 42	0.14	0.47	1.28	2.36	3.46	4.36
ESS1.5- 44	0.14	0.49	1.31	2.49	3.54	4.61
ESS1.5- 45	0.15	0.51	1.33	2.56	3.55	4.73
ESS1.5- 46	0.15	0.52	1.36	2.63	3.64	4.86
ESS1.5- 48	0.16	0.55	1.38	2.77	3.83	5.11
ESS1.5- 50	0.17	0.58	1.45	2.90	4.02	5.36
ESS1.5- 52	0.18	0.60	1.52	3.04	4.21	5.62
ESS1.5- 54	0.19	0.63	1.59	3.18	4.40	5.45
ESS1.5- 55	0.19	0.65	1.62	3.25	4.50	5.57
ESS1.5- 56	0.19	0.66	1.66	3.32	4.59	5.69
ESS1.5- 58	0.20	0.69	1.72	3.45	4.78	5.92
ESS1.5- 60	0.21	0.71	1.79	3.57	4.97	6.16
ESS1.5- 62	0.22	0.74	1.86	3.59	5.16	6.39
ESS1.5- 64	0.23	0.77	1.93	3.63	5.36	6.63
ESS1.5- 65	0.23	0.78	1.97	3.70	5.45	6.75
ESS1.5- 66	0.24	0.80	2.00	3.73	5.55	6.87
ESS1.5- 68	0.24	0.82	2.07	3.82	5.68	7.11
ESS1.5- 70	0.25	0.85	2.14	3.95	5.73	7.34
ESS1.5- 72	0.26	0.88	2.21	4.08	5.93	7.58
ESS1.5- 75	0.27	0.92	2.31	4.27	5.95	7.94
ESS1.5- 76	0.28	0.94	2.35	4.34	6.04	8.06
ESS1.5- 80	0.29	0.99	2.49	4.59	6.40	8.53
ESS1.5- 84	0.31	1.05	2.62	4.85	6.76	8.52
ESS1.5- 85	0.31	1.06	2.66	4.91	6.85	8.85
ESS1.5- 88	0.33	1.10	2.76	5.11	7.11	9.01
ESS1.5- 90	0.34	1.13	2.83	5.23	7.29	9.08
ESS1.5- 95	0.36	1.20	3.01	5.56	7.74	9.64
ESS1.5-100	0.38	1.27	3.18	5.88	8.19	10.1

標準平齒車 許容傳達標準動力表(kW)

ESS 2.0 平齒車

rpm 규격	rpm					
	30	100	300	600	900	1200
ESS2- 08	0.037	0.12	0.37	0.74	0.93	1.24
ESS2- 10	0.045	0.16	0.45	0.91	1.14	1.53
ESS2- 12	0.059	0.19	0.59	0.19	1.49	1.99
ESS2- 13	0.068	0.22	0.68	1.36	1.70	2.26
ESS2- 14	0.076	0.25	0.76	1.53	1.91	2.55
ESS2- 15	0.085	0.28	0.85	1.70	2.12	2.83
ESS2- 16	0.093	0.31	0.93	1.56	2.34	3.12
ESS2- 17	0.10	0.34	1.02	1.70	2.56	3.41
ESS2- 18	0.11	0.37	1.11	1.85	2.78	3.70
ESS2- 19	0.12	0.40	1.20	2.00	3.00	4.00
ESS2- 20	0.12	0.43	1.29	2.15	3.22	4.30
ESS2- 21	0.13	0.46	1.38	2.30	3.45	4.60
ESS2- 22	0.14	0.49	1.47	2.45	3.68	4.90
ESS2- 23	0.15	0.52	1.56	2.60	3.91	5.09
ESS2- 24	0.16	0.55	1.65	2.76	4.14	5.21
ESS2- 25	0.17	0.58	1.74	2.91	4.37	5.38
ESS2- 26	0.18	0.61	1.84	3.06	4.60	5.66
ESS2- 27	0.19	0.64	1.93	3.22	4.83	5.95
ESS2- 28	0.20	0.67	2.00	3.37	5.06	6.23
ESS2- 29	0.21	0.70	2.02	3.53	5.30	6.52
ESS2- 30	0.22	0.73	2.12	3.69	5.53	6.81
ESS2- 32	0.24	0.80	2.16	4.00	5.54	7.39
ESS2- 34	0.25	0.86	2.21	4.32	5.98	7.98
ESS2- 35	0.26	0.89	2.24	4.48	6.20	8.27
ESS2- 36	0.27	0.92	2.32	4.64	6.42	8.56
ESS2- 38	0.29	0.99	2.48	4.96	6.86	9.05
ESS2- 40	0.31	1.05	2.64	5.28	7.31	9.15
ESS2- 42	0.33	1.12	2.80	5.60	7.75	9.60
ESS2- 44	0.35	1.18	2.96	5.92	8.20	10.1
ESS2- 45	0.36	1.21	3.04	6.06	8.42	10.4
ESS2- 46	0.37	1.24	3.12	6.08	8.64	10.7
ESS2- 48	0.39	1.31	3.28	6.24	9.09	11.2
ESS2- 50	0.41	1.37	3.44	6.36	9.54	11.8
ESS2- 52	0.43	1.44	3.60	6.66	9.69	12.3
ESS2- 54	0.45	1.50	3.77	6.96	9.90	12.9
ESS2- 55	0.46	1.54	3.85	7.11	9.99	13.2
ESS2- 56	0.47	1.57	3.93	7.26	10.1	13.4
ESS2- 58	0.49	1.63	4.09	7.56	10.5	14.0
ESS2- 60	0.51	1.70	4.26	7.86	10.9	14.6
ESS2- 62	0.53	1.76	4.42	8.16	11.3	14.6
ESS2- 64	0.55	1.83	4.58	8.47	11.7	14.9
ESS2- 65	0.56	1.86	4.67	8.62	12.0	15.1
ESS2- 66	0.57	1.90	4.75	8.77	12.2	15.2
ESS2- 68	0.58	1.96	4.91	9.07	12.6	15.7
ESS2- 70	0.60	2.03	5.08	9.37	13.0	16.2
ESS2- 72	0.62	2.09	5.24	9.68	13.4	16.7
ESS2- 75	0.65	2.19	5.49	10.1	14.1	17.5
ESS2- 76	0.66	2.22	5.57	10.1	14.3	17.8
ESS2- 80	0.70	2.36	5.90	10.2	15.1	18.8
ESS2- 84	0.74	2.49	6.23	10.6	15.1	19.9
ESS2- 85	0.75	2.52	6.31	10.8	15.7	20.2
ESS2- 88	0.78	2.62	6.56	11.2	16.0	21
ESS2- 90	0.80	2.69	6.72	11.5	16.1	21.5
ESS2- 95	0.85	2.85	6.97	12.2	17.1	22.8
ESS2-100	0.90	2.51	7.14	12.9	18.1	-
ESS2-120	1.10	3.07	8.50	15.7	22.1	-

ESS 2.5 平齒車

rpm 규격	rpm					
	30	100	300	600	900	1200
ESS2.5- 08	0.07	0.25	0.77	1.55	1.94	2.59
ESS2.5- 10	0.09	0.31	0.97	1.94	2.43	3.24
ESS2.5- 12	0.11	0.38	1.16	2.21	2.92	3.89
ESS2.5- 13	0.13	0.44	1.33	2.33	3.32	4.43
ESS2.5- 14	0.14	0.49	1.49	2.49	3.73	4.98
ESS2.5- 15	0.16	0.55	1.66	2.76	4.15	5.53
ESS2.5- 16	0.18	0.61	1.83	3.05	4.57	6.10
ESS2.5- 17	0.20	0.66	2.00	3.33	5.00	6.67
ESS2.5- 18	0.21	0.72	2.17	3.62	5.43	7.24
ESS2.5- 19	0.23	0.78	2.34	3.91	5.86	7.76
ESS2.5- 20	0.25	0.84	2.52	4.20	6.30	7.82
ESS2.5- 21	0.26	0.89	2.69	4.49	6.74	8.30
ESS2.5- 22	0.28	0.95	2.87	4.79	7.19	8.85
ESS2.5- 23	0.30	1.01	3.05	5.09	7.63	9.40
ESS2.5- 24	0.32	1.07	3.14	5.39	8.08	9.95
ESS2.5- 25	0.34	1.13	3.23	5.69	8.29	10.5
ESS2.5- 26	0.35	1.19	3.30	5.99	8.53	11.0
ESS2.5- 27	0.37	1.25	3.41	6.29	8.71	11.6
ESS2.5- 28	0.39	1.32	3.43	6.60	9.13	12.1
ESS2.5- 29	0.41	1.38	3.45	6.90	9.56	12.7
ESS2.5- 30	0.43	1.44	3.60	7.21	9.98	13.3
ESS2.5- 32	0.46	1.56	3.91	7.82	10.8	13.4
ESS2.5- 34	0.50	1.68	4.22	8.44	11.6	14.4
ESS2.5- 35	0.52	1.75	4.37	8.75	12.1	15.0
ESS2.5- 36	0.54	1.81	4.53	9.06	12.5	15.5
ESS2.5- 38	0.58	1.93	4.84	9.52	13.4	16.6
ESS2.5- 40	0.61	2.06	5.15	9.68	14.2	17.6
ESS2.5- 42	0.65	2.18	5.47	10.0	14.8	18.7
ESS2.5- 44	0.69	2.31	5.78	10.6	15.1	19.8
ESS2.5- 45	0.71	2.37	5.94	10.9	15.2	20.3
ESS2.5- 46	0.73	2.44	6.10	11.2	15.6	20.9
ESS2.5- 48	0.76	2.56	6.41	11.8	16.4	21.9
ESS2.5- 50	0.80	2.69	6.73	12.4	17.3	22.5
ESS2.5- 52	0.84	2.81	7.04	13.0	18.1	23.0
ESS2.5- 54	0.88	2.94	7.36	13.6	18.9	23.5
ESS2.5- 55	0.90	3.01	7.52	13.8	19.3	24.0
ESS2.5- 56	0.92	3.07	7.68	14.1	19.7	24.5
ESS2.5- 58	0.96	3.20	8.00	14.7	20.5	25.6
ESS2.5- 60	0.99	3.32	8.32	15.3	21.4	26.6
ESS2.5- 62	1.03	3.45	8.64	15.9	22.2	27.6
ESS2.5- 64	1.07	3.58	8.96	15.3	23.0	28.6
ESS2.5- 65	1.09	3.64	9.12	15.6	23.4	29.1
ESS2.5- 66	1.11	3.71	9.28	15.9	23.5	29.7
ESS2.5- 68	1.15	3.84	9.60	16.4	23.7	30.7
ESS2.5- 70	1.19	3.96	9.92	17.0	23.8	31.7
ESS2.5- 72	1.22	4.09	10.2	17.5	24.5	32.7
ESS2.5- 75	1.28	4.28	10.7	18.3	25.7	34.3
ESS2.5- 76	1.30	4.35	10.8	18.6	26.1	34.8
ESS2.5- 80	1.38	4.36	10.9	19.7	27.6	-
ESS2.5- 90	1.57	4.37	12.1	22.5	31.5	-
ESS2.5-100	1.77	4.91	13.6	25.2	35.4	-
ESS2.5-120	2.15	5.99	16.6	28.7	-	-

標準平齒車 許容傳達標準動力表(kW)

※ 아래 제품의 허용전달동력표는 재질이 SM45C 제품으로 동일한 모듈 및 잇수인 조건에서 ESSA, ESSB는 동등한 강도 및 동력전달이 가능합니다.

ESS 3.0 平齒車

rpm 규격	30	100	300	600	900	1200
ESS3- 08	0.13	0.44	1.34	2.24	3.36	4.48
ESS3- 10	0.16	0.55	1.67	2.80	4.20	5.60
ESS3- 12	0.20	0.67	2.01	3.36	5.04	6.73
ESS3- 13	0.22	0.76	2.29	3.83	5.74	7.66
ESS3- 14	0.25	0.86	2.58	4.30	6.45	8.60
ESS3- 15	0.28	0.95	2.87	4.78	7.17	9.56
ESS3- 16	0.31	1.05	3.16	5.27	7.90	9.73
ESS3- 17	0.34	1.15	3.45	5.76	8.64	10.6
ESS3- 18	0.37	1.25	3.75	6.25	9.38	11.5
ESS3- 19	0.40	1.35	4.05	6.76	10.1	12.4
ESS3- 20	0.43	1.45	4.14	7.26	10.8	13.4
ESS3- 21	0.46	1.55	4.35	7.77	11.4	14.3
ESS3- 22	0.49	1.65	4.39	8.28	11.6	15.2
ESS3- 23	0.52	1.75	4.66	8.79	12.1	16.2
ESS3- 24	0.55	1.86	4.70	9.31	12.8	17.1
ESS3- 25	0.59	1.96	4.91	9.83	13.6	18.1
ESS3- 26	0.62	2.07	5.17	10.3	14.3	18.6
ESS3- 27	0.65	2.17	5.44	10.8	15.0	19.1
ESS3- 28	0.68	2.28	5.70	11.4	15.7	19.5
ESS3- 29	0.71	2.38	5.96	11.9	16.5	20.4
ESS3- 30	0.74	2.49	6.23	12.4	17.2	21.3
ESS3- 32	0.81	2.70	6.76	12.4	18.7	23.1
ESS3- 34	0.87	2.91	7.29	13.4	20.1	25.0
ESS3- 35	0.90	3.02	7.56	13.9	20.2	25.9
ESS3- 36	0.93	3.13	7.83	14.4	20.9	26.8
ESS3- 38	1.00	3.34	8.37	15.4	21.5	28.7
ESS3- 40	1.06	3.56	8.91	16.4	22.9	30.5
ESS3- 42	1.13	3.78	9.45	17.4	24.3	31.9
ESS3- 44	1.19	3.99	9.99	18.4	25.7	32.4
ESS3- 45	1.23	4.10	10.2	18.9	26.4	32.8
ESS3- 46	1.26	4.21	10.5	19.4	27.1	33.7
ESS3- 48	1.33	4.43	11.0	20.4	28.5	35.4
ESS3- 50	1.39	4.65	11.6	21.4	29.9	37.2
ESS3- 52	1.46	4.87	12.1	21.8	31.3	38.9
ESS3- 54	1.52	5.09	12.7	22.2	32.7	40.7
ESS3- 55	1.56	5.16	13.0	22.4	33.1	41.6
ESS3- 56	1.59	5.20	13.2	22.7	33.4	42.4
ESS3- 58	1.65	5.25	13.8	23.7	34.1	44.2
ESS3- 60	1.72	5.31	14.2	24.6	34.5	46.0
ESS3- 62	1.79	5.34	14.3	25.5	35.8	47.7
ESS3- 64	1.85	5.53	14.5	26.5	37.1	-
ESS3- 65	1.89	5.60	14.8	27.0	37.8	-
ESS3- 66	1.92	5.71	14.9	27.4	38.4	-
ESS3- 68	1.99	5.75	15.3	28.4	39.8	-
ESS3- 70	2.05	5.90	15.8	29.3	41.1	-
ESS3- 72	2.12	5.97	16.3	30.3	42.4	-
ESS3- 75	2.22	6.00	17.1	31.7	44.4	-
ESS3- 76	2.25	6.27	17.3	32.2	45.1	-
ESS3- 80	2.39	6.64	18.3	34.1	47.8	-
ESS3- 90	2.72	7.56	20.9	36.3	-	-
ESS3-100	3.05	8.49	23.5	40.7	-	-
ESS3-120	3.73	10.3	26.6	49.7	-	-

ESS 4.0 平齒車

rpm 규격	30	100	300	600	900	1200
ESS4-12	0.47	1.59	4.78	7.97	11.9	14.7
ESS4-13	0.54	1.81	5.44	9.07	13.6	16.7
ESS4-14	0.61	2.04	6.12	10.2	15.3	18.8
ESS4-15	0.68	2.26	6.24	11.3	17.0	20.9
ESS4-16	0.74	2.49	6.80	12.4	17.2	23.0
ESS4-17	0.81	2.73	6.83	13.6	18.9	25.2
ESS4-18	0.89	2.96	7.41	14.8	20.5	27.3
ESS4-19	0.96	3.20	8.01	16.0	22.1	29.5
ESS4-20	1.03	3.44	8.61	17.2	23.8	29.5
ESS4-21	1.10	3.68	9.21	18.4	25.5	31.5
ESS4-22	1.17	3.92	9.81	19.6	27.1	33.6
ESS4-23	1.25	4.17	10.4	20.8	28.8	35.7
ESS4-24	1.32	4.41	11.0	20.3	30.5	37.8
ESS4-25	1.39	4.66	11.6	21.5	32.2	39.9
ESS4-26	1.47	4.91	12.2	22.6	33.1	42.0
ESS4-27	1.54	5.10	12.8	23.8	33.9	44.2
ESS4-28	1.62	5.15	13.5	24.9	34.7	46.3
ESS4-29	1.69	5.65	14.1	26.1	36.3	48.4
ESS4-30	1.77	5.90	14.7	27.2	37.9	50.6
ESS4-32	1.92	6.41	16.0	29.5	41.2	51.2
ESS4-34	2.07	6.91	17.2	31.9	44.4	55.3
ESS4-35	2.15	7.17	17.9	33.1	46.1	57.3
ESS4-36	2.22	7.42	18.5	34.2	47.7	59.4
ESS4-38	2.38	7.93	19.8	36.2	51.0	63.4
ESS4-40	2.53	8.44	21.1	36.6	54.3	67.5
ESS4-42	2.68	8.96	22.4	38.4	57.6	71.7
ESS4-44	2.84	9.19	23.6	40.6	56.8	75.8
ESS4-45	2.92	9.47	24.2	41.7	58.4	77.8
ESS4-46	2.99	9.62	24.3	42.8	59.9	79.9
ESS4-48	3.15	9.73	24.9	45.0	63.0	-
ESS4-50	3.30	9.75	25.4	47.2	66.1	-
ESS4-52	3.46	9.99	26.6	49.4	69.2	-
ESS4-54	3.82	10.0	27.8	51.7	72.4	-
ESS4-55	3.69	10.2	28.4	52.8	73.9	-
ESS4-56	3.77	10.4	29.0	53.9	75.5	-
ESS4-58	3.93	10.9	30.2	56.2	78.6	-
ESS4-60	4.09	11.3	31.4	58.3	81.8	-
ESS4-62	4.24	11.7	32.6	58.7	84.9	-
ESS4-64	4.40	12.2	33.8	59.7	-	-
ESS4-65	4.48	12.4	34.4	60.6	-	-
ESS4-66	4.56	12.6	35.0	60.8	-	-
ESS4-68	4.71	13.1	36.3	62.9	-	-
ESS4-70	4.87	13.5	37.5	65.0	-	-
ESS4-80	5.66	15.7	40.4	75.5	-	-

標準平齒車 許容傳達標準動力表(kW)

■ ESS 5.0 平齒車

rpm 규격	rpm					
	30	100	300	600	900	1200
ESS5-12	0.93	3.11	8.86	15.5	23.3	28.7
ESS5-13	1.06	3.54	9.34	17.7	24.5	32.7
ESS5-14	1.19	3.98	9.96	19.9	27.5	36.7
ESS5-15	1.32	4.43	11.0	22.1	30.6	40.8
ESS5-16	1.46	4.88	12.2	24.4	33.7	41.8
ESS5-17	1.60	5.33	13.3	26.6	36.9	45.7
ESS5-18	1.73	5.79	14.4	28.9	40.1	49.6
ESS5-19	1.87	6.25	15.6	31.2	43.3	53.6
ESS5-20	2.01	6.72	16.8	31.0	46.5	57.6
ESS5-21	2.15	7.19	17.9	33.2	49.3	61.6
ESS5-22	2.30	7.67	19.1	35.4	49.8	65.7
ESS5-23	2.44	8.14	20.3	37.6	52.3	69.8
ESS5-24	2.58	8.62	21.5	39.8	55.4	73.9
ESS5-25	2.73	9.10	22.7	42.0	58.5	76.7
ESS5-26	2.87	9.59	23.9	44.2	61.6	78.0
ESS5-27	3.02	10.0	25.1	46.5	64.7	80.6
ESS5-28	3.16	10.5	26.4	48.7	67.8	84.4
ESS5-29	3.31	11.0	27.6	51.0	71.0	88.4
ESS5-30	3.46	11.5	28.8	53.2	74.1	92.3
ESS5-32	3.75	12.5	31.3	53.6	80.5	100
ESS5-34	4.05	13.5	33.7	57.9	81.0	108
ESS5-35	4.20	14.0	35.0	60.0	84.0	112
ESS5-36	4.35	14.5	36.2	62.1	87.0	116
ESS5-38	4.65	15.5	38.0	66.4	93.0	124
ESS5-40	4.95	15.7	38.7	70.7	99.0	-
ESS5-42	5.25	16.2	40.3	75.0	105	-
ESS5-44	5.5	16.4	42.7	79.3	111	-
ESS5-45	5.70	16.8	43.8	81.4	114	-
ESS5-46	5.85	16.9	45.0	83.6	117	-
ESS5-48	6.15	17.1	47.3	87.9	123	-
ESS5-50	6.46	17.9	49.7	92.3	129	-
ESS5-52	6.76	18.7	52.0	90.2	-	-
ESS5-54	7.07	19.6	54.4	94.2	-	-
ESS5-55	7.22	20.0	55.5	96.3	-	-
ESS5-56	7.37	20.4	56.7	98.3	-	-
ESS5-58	7.68	21.3	59.1	102	-	-
ESS5-60	7.98	22.1	61.4	106	-	-

■ ESS 6.0 平齒車

rpm 규격	rpm					
	30	100	300	600	900	1200
ESS6-12	1.59	5.33	13.3	26.6	36.9	49.2
ESS6-13	1.82	6.06	15.1	30.3	42.0	56.0
ESS6-14	2.04	6.81	17.0	34.0	47.1	58.4
ESS6-15	2.27	7.57	18.9	37.8	52.4	64.9
ESS6-16	2.50	8.34	20.8	38.5	57.8	71.5
ESS6-17	2.73	9.12	22.8	42.1	63.1	78.2
ESS6-18	2.97	9.91	24.7	45.7	63.7	84.9
ESS6-19	3.21	10.7	26.7	49.4	68.8	91.7
ESS6-20	3.45	11.5	28.7	53.1	73.9	98.6
ESS6-21	3.69	12.3	30.7	56.8	79.1	104
ESS6-22	3.93	13.1	32.8	60.5	84.3	105
ESS6-23	4.18	13.9	34.8	64.3	89.6	111
ESS6-24	4.42	14.7	36.8	68.1	94.8	118
ESS6-25	4.67	15.5	38.9	71.9	100	124
ESS6-26	4.92	16.4	41.0	75.7	105	131
ESS6-27	5.17	17.2	43.0	73.8	110	137
ESS6-28	5.42	18.0	45.1	77.4	116	144
ESS6-30	5.92	19.7	49.3	84.6	118	157
ESS6-32	6.42	17.8	49.4	91.8	128	-
ESS6-34	6.93	19.2	53.3	99.0	138	-
ESS6-35	7.18	19.9	55.3	102	143	-
ESS6-36	7.44	20.6	57.2	106	148	-
ESS6-38	7.95	22.0	61.1	113	159	-
ESS6-40	8.46	23.5	65.1	120	169	-
ESS6-42	8.98	24.9	69.1	128	179	-
ESS6-44	9.50	26.3	73.0	126	-	-
ESS6-45	9.75	27.1	75.0	130	-	-
ESS6-46	10.0	27.8	77.0	133	-	-
ESS6-48	10.5	29.2	81.0	140	-	-
ESS6-50	11.0	30.7	85.0	147	-	-

■ ESS 8.0 平齒車

rpm 규격	rpm					
	30	100	300	600	900	1200
ESS8-12	3.51	11.7	29.3	54.1	81.1	100
ESS8-13	4.00	13.3	33.3	61.6	92.4	114
ESS8-14	4.49	14.9	37.4	69.2	96.4	128
ESS8-15	5.00	16.6	41.6	76.9	107	142
ESS8-16	5.51	18.3	45.9	84.7	118	146
ESS8-17	6.02	20.0	50.2	92.6	129	160
ESS8-18	6.54	21.8	54.5	100	140	174
ESS8-19	7.06	23.5	58.8	108	151	188
ESS8-20	7.59	25.3	63.2	108	162	202
ESS8-21	8.12	27.0	67.7	116	173	216
ESS8-22	8.66	28.5	72.1	123	174	230
ESS8-23	9.19	28.8	74.9	131	183	245
ESS8-24	9.73	28.9	76.6	139	194	-
ESS8-25	10.2	30.0	79.0	146	205	-
ESS8-26	10.8	30.6	83.2	154	216	-
ESS8-27	11.3	31.5	87.4	164	227	-
ESS8-28	11.9	33.1	91.7	170	238	-
ESS8-30	13.0	36.1	100	186	260	-